

Protecta - Fluorescent Luminaires

IECEX, ATEX, Ex n

INSTALLATION, OPERATION AND MAINTENANCE INSTRUCTIONS

Normal and Emergency Models

Important:

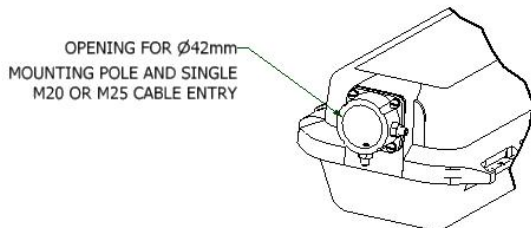
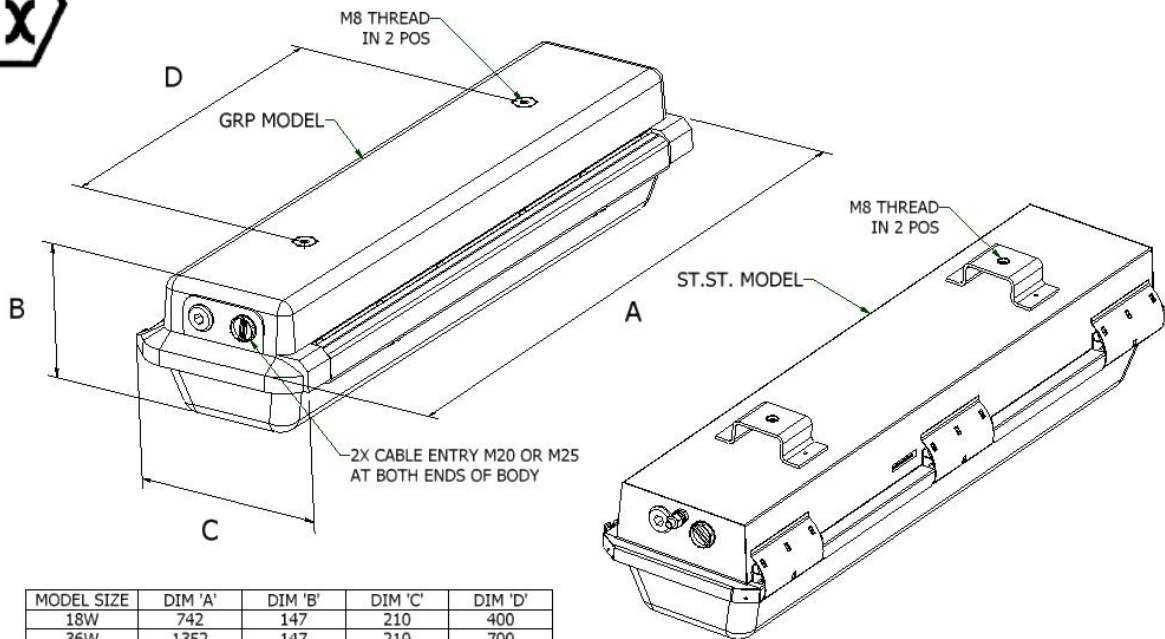

Please read these instructions carefully before installing or maintaining this equipment. Good electrical practices should be followed at all times and this data should be used as a guide only.



POLE MOUNT MODEL
2FT & 4FT



Specification and ATEX Declaration

Type of Protection	Ex nA (non-sparking)		
Protection Standard	EN 60079-0:2006 EN 61241-1:2004 IEC 60079-0:2004 IEC 61241-1:2004	EN 60079-15:2005 IEC 60079-15:2005	EN 61241-0:2004 IEC 61241-0:2006
Area of Application	Zone 2, Zone 22 and Zone 21 areas to EN 60079-10 and installation to EN 60079-14		
ATEX Equipment Classification	Group II Category 3 G Group II Category 3 D Group II Category 2 D		
Equipment Coding	 Ex nA II T4 (Gas) Ex tD A22 IP6X T85°C (Dust Category 3) Ex tD A21 IP6X T85°C (Dust Category 2)		
Certificate	EC Type Certificate No. BAS08ATEX0227 (Category 3GD) EC Type Certificate No. BAS08ATEX0228 (Category 2D) IECEX Type Certificate No. IECEX BAS 08.0075		
Ingress Protection	IP66/67 to BS EN 60529		
CE Mark	 The CE marking of this product applies to "The Electrical Equipment (Safety) Regulations 2006", "The Electromagnetic Compatibility Regulations 2004", the "Waste Electrical and Electronic Equipment Regulations 2006" and the "Equipment and Protective Systems intended for use in Explosive Atmospheres Regulations 1996". [This legislation is the equivalent in UK law of EC directives 2006/95/EC, 2004/108/EC and 2002/96/EC respectively].		
ATEX Declaration	The Equipment is declared to meet the provisions of the ATEX directive (94/9/EC) by reason of the EC Type Examination and compliance with the Essential Health and Safety Requirements.		

I MacLeod Technical Manager

SPECIAL CONDITIONS FOR SAFE USE

None

1.0 Introduction – Protecta Ex nA Fluorescent Luminaire

1.1 General

The type of protection is Ex nA.
 The Protecta series Ex nA fluorescent luminaires are surface mounted or suspended suitable for use in Zone 2 (Gas) & Zone 22 areas (Dust). Also suitable for Zone 21 Dust only applications. The standard suspension is via two M8 tapped holes in brass bushes in the top of the body. They are mainly used in harsh environments. The enclosure is constructed of either a corrosion resistant glass reinforced polyester body or Stainless Steel body hinged to an injection moulded polycarbonate diffuser. The control gear and lampholders are mounted on a removable tray that for maintenance purposes has hanging straps.

Note: *The ratings are listed in TABLES 1-4.*

1.2 Application

The luminaire is designed to be safe in normal operation. The luminaire should not be used where there are environmental, vibration or shock conditions above the normal for fixed installations. The gaskets should not be exposed to hydrocarbons in liquid or high concentration vapour states. The luminaire is suitable for applications where Category 3 apparatus can be used for Gas and Dust. The luminaire is also suitable for

Category 2 Dust Only applications. The type examination does not address suitability for portable applications.

2.0 Storage

Luminaires are to be stored in cool dry conditions preventing ingress of moisture and condensation. Any specific instructions concerning emergency luminaires must be complied with.

3.0 Installation and Safety

3.1 General

There are no health hazards associated with this product whilst in normal use. However, care should be exercised during the following operations. Installation should be carried out in accordance with *BS EN 60079-14* or the local hazardous area code of practice, whichever is appropriate.

In the UK, the requirements of the '*Health and Safety at Work Act*' must be met.

Handling and electrical work associated with this product to be in accordance with the '*Manual Handling Operations Regulations*' and '*Electricity at Work Regulations, 1989*'. Your attention is drawn to the paragraphs (i) 'Electrical Supplies', (ii) 'Electrical Fault Finding and Replacement' and (iii) 'Inspection and Maintenance'. The luminaires are Class 1 and should be effectively earthed.

The luminaires are quite heavy and suitable means of handling on installation must be provided.

Certification details on the rating plate must be verified against the application requirements before installation. The information in this leaflet is correct at the time of publication. The company reserves the right to make specification changes as required.

The polycarbonate diffuser presents a potential source of ignition by **electrostatic electricity**. The diffuser should only be cleaned using a damp cloth. The luminaire should not be mounted very near to any probable location of fast moving stream of dry air, steam etc. which could generate a propagating brush static discharge.

3.1.1 Use in Combustible Dust Atmospheres – Zone 21 and Zone 22

Where the equipment is used in ignitable dust atmospheres reference must be made to the selection and installation standards in order that the equipment is used correctly. In particular this applies to the de-rating of surface temperature for use where dust clouds may be present. Dust layers should not be allowed to accumulate on the fitting surface and good housekeeping is required for safe operation. Dust in layers has the potential to form ignitable clouds and to burn at lower temperatures.

Refer to EN60079-14 for additional details of selection, installation and maintenance.

3.1.2 Hybrid Mixtures – Gas plus Dust.

Where Hybrid mixtures exist as defined in EN1127 as a potentially explosive atmosphere, consideration should be given to verifying that the maximum surface temperature of the luminaire is below the ignition temperature of the hybrid mixture.

3.2 Tools

3mm and 4mm flat blade screwdriver and large cross-head screwdriver.

Suitable spanners for installing cable glands. Pliers, knife, wire strippers/cutters.

3.3 Electrical Supplies

The supply voltage and frequency should be specified when ordering. A maximum voltage variation of +6%/-6% on the nominal is expected. (The safety limit for T rating is +10%). Luminaires should not be operated continuously at more than +6%/-10% of the rated supply voltage of the control gear.

3.4 Lamps

The lamps used in the range can be T8 bi-pin fluorescent with G13 cap. Lamp caps are to IEC 60061, lamp dimensions and safety to IEC 61195 and lamp performance to IEC 60081.

3.5 Mounting

Luminaires should be installed where access for maintenance is practical and in accordance with any lighting design information provided for the installation. The standard suspension is via two M8 tapped holes in brass bushes in the top of the body. (At 400mm centres for 18W and 700mm centres for the 36W & 58W models). The brass bushes and lock nuts should not be removed during installation. Various adaptors, pole clamps and suspension brackets are available to order. The 18W & 36W models are available with integral side entry for 42 mm diameter poles.

3.5.1 Opening and Closing the Cover

The procedure for opening the cover on the GRP model is as follows:

Insert the tool into one of the slots in the clamping bar with the end of the tool located into the outer flange of the body as a fulcrum point, a wide blade screwdriver is recommended. Gently lever the tool away from the diffuser; the clamping bar will begin to open. Insert the tool in the other clamping bar slot and gently lever away from the diffuser, the clamping bar will open and the hinge will retain the cover. Should difficulty be experienced, reinsert the tool in the first slot and repeat the procedure.

The procedure for closing and securing the cover is as follows:

Ensure the hinge mechanism is clear of any obstruction and then swing the diffuser into the closed position. Support the diffuser in position whilst pushing the clamp bar over the edge of the diffuser. Apply even pressure at both ends of the bar and press the bar over centre.

The procedure for opening the cover on the St.St. model is as follows:

Insert the tool under the stainless steel clamp with the end of the tool located, a wide blade screwdriver is recommended. Gently lever the tool upwards towards the diffuser and the clamp will begin to open. Repeat the procedure for all the clamps. The integral hinge will retain the cover.

The procedure for closing and securing the cover is as follows:

Ensure the hinge mechanism is clear of any obstruction and then swing the diffuser into the closed position. Support the diffuser in position whilst pushing each of the clamps over the edge of the diffuser.

3.6 Cabling and Cable Glands

3.6.1 Cables

The Protecta series have the facility both looping and through wiring.

The temperature conditions of the supply cable entry point are such that 70°C (ordinary PVC) cable can be used in most luminaire models. Where MCB's are used, the type with the higher short time tripping current ratio used for motor starting and lighting should be specified. The standard maximum looping size is 4mm². An internal earth tag can be fitted to the cable gland.

The pole-mounted version has a cable gland fitted that will seal onto cables in the range 13 to 18 mm OD. The gland does not have provision for armour clamping.

Note: *Through wiring when used, is subject to a maximum current of 16A.*

3.6.2 Cable Gland Types

The installer and user must take responsibility for the selection of cables, cable glands and seals. The cable glands must be suitable for the application. Cable glands for entry into Ex enclosures when fitted with any gland to body sealing method and supply cable, must reliably maintain the IP rating of the enclosure with a minimum value of IP66 / 67 or IP6X for conductive dust.. Nylon washers are provided with the unit to seal between the gland body and the luminaire. Cable glands and sealing plugs for unused entries must have ATEX component approval or be certified to EN 50014 or EN 60079-0. For installation outside the EU suitable cable glands in accordance with IEC 60079-0 will meet the technical requirements. Four entries are provided on the standard model. Three entries are fitted with suitably approved blanking plugs, the fourth entry with a transit plug that is not suitable for use in service. M20 x 1.5 entries are standard, other sizes are available on request. The standard entry configuration is with an earthed metal plate with tapped holes mounted in the body. Where brass cable glands are to be installed, cadmium or nickel plating should be used.

Special Conditions:

All unused cable entries must be fitted with a blanking element. The permitted component certified blanking elements for this range of luminaires are listed on the certificate.

3.6.3 Cable Gland Types (Pole Mount Version)

Cable glands for entry into Ex enclosures when fitted with any gland to body sealing method and supply cable, must reliably maintain the IP rating of the enclosure with a minimum value of IP66 / 67 or IP6X for conductive dust. The pole mount version of the luminaire is supplied with a suitable Ex cable gland Nylon washers are provided with the unit to seal between the gland body and the luminaire.

3.7 Cabling

Access for cabling is via the hinged diffuser cover. The reflector/gear tray is swung down by loosening the four fixing screws and sliding over the keyhole slots. This gives access to the mains terminals. The tray can be removed by undoing the spring clips on the suspension cables. Any earth tag connections should be fitted. The connecting terminals are identified and the conductors should be bared back so that they make full contact in the terminals, but the bare conductor should not be more than 1mm beyond the terminal. Unused terminal screws should be tightened. The cores must be identified by polarity and connected in accordance with the terminal markings. Before re-fitting the cover, a final check on the correctness of connections should be made.

For the standard mains incoming terminal block, the through current rating is 16A. 4mm² terminals are standard. Luminaires fitted with Weidmuller MK6 (Marked - IECEx SIR.05.0037U) are suitable for 36A max current rating and 6mm² cable.

Luminaires fitted with Wago Type 262 (Marked - IECEx PTB.04.0004U) are suitable for 30A max current rating and 6mm² max cable.

Screw type or screw-less “cage clamp” terminals are fitted in the range of luminaires. Mains terminal blocks are marked L N Earth.

3.7.1 Fitting Lamps

Before opening the diffuser cover ensure that the luminaire is isolated from mains supply. Access for re-lamping is via the diffuser cover; care is to be taken, as there is no suspension facility for the diffuser cover. Make sure that the correct lamp is selected. The lampholders are tombstone type, place the lamp in the lampholder and rotate 90° in lampholder. When inserting new lamps ensure pins and lampholder connection is centralised. Replace diffuser cover and snap clips into place.

3.7.2 Fused Terminal Blocks

When a fused terminal block has been fitted, it is essential that the metal clamp supplied retain the fuse holder.

3.8 Inspection and Maintenance

Visual inspection should be carried out at a minimum of 12 monthly intervals and more frequently if conditions are severe. The time between lamp changes could be very infrequent and this is too long a period without inspection.

3.8.1 Routine Examination

The equipment must be de-energised before opening. Individual organisations will have their own procedures. What follows are guidelines based on *BS EN 60079-17* and on our experience:

1 Ensure lamps are lit when energised by mains supply.

Visually check diffuser cover for damage. This should only be cleaned using a damp cloth to avoid static and only use recommended detergents for polycarbonate. If the polycarbonate is discoloured or damaged, a new diffuser cover must be fitted.

When de-energised and left to cool, there should be no significant sign of internal moisture. If there are any signs of water ingress, the luminaire should be opened up, dried and any likely ingress points eliminated by re-gasketing or other replacements.

4 Check cable gland for tightness and nip up if required.

5 Check any external and internal earths.

6 Check all terminations are firmly screwed down, tighten if necessary.

7 If it has been suspected that the luminaire has suffered mechanical damage, a stringent workshop check on all components should be made. All components can be removed from the luminaire for inspection.

Avoid the build up of dust layers by regular cleaning and again clean only using a damp cloth.

3.8.2 Routine Testing of Emergency Lighting Functions

Users should ensure that the performance of emergency lighting remains adequate for their purposes by conducting periodic tests and recording the results. Requirements will differ between countries, applications and organisations. In the United Kingdom BS 5266 Pt1 gives guidance on testing.

3.9 Electrical Fault Finding and Replacement

The supply must be isolated before opening the luminaire.

Any live fault finding must be done by a competent electrician and, if carried out with luminaire in place, under a permit to work. Where the control gear is copper and iron, the fitting can be tested for continuity of connections. When electronic high frequency gear is fitted do not megger.

If lamps go out repeatedly, and replacement lamps do not work or expected life is reduced, where applicable replacement starters should be tried. However, if this does not correct the fault the control gear should be returned for replacement/testing. The electronic starter, and where specified, the High frequency ballast will cut out if lamps are defective. The starter and High frequency ballasts are approved components. On re-assembly, all faulty/damaged wiring should be replaced and connections checked.

3.9.1 Battery Check and Replacement

Do not open luminaire when a hazardous atmosphere is present. Isolate before opening. The battery is detached at the plug and socket. Remove the two screws to release the battery. Re-assembly is in reverse order.

Important : *Care must be taken not to short the leads together as this can cause sparking which, in turn, could lead to a fire.*

The emergency duration is 3 hours. This is in accordance with EN 60598 2-22. The battery must be replaced when the duration is not acceptable.

ONLY USE REPLACEMENT BATTERY PACK - Pt No. PROT2-0005, manufactured by Chalmit Lighting
Protect the batteries from water ingress and mechanical damage then transport from the hazardous area as soon as practical. Take care to fully discharge batteries before transporting or otherwise ensure that there can be no release of stored energy in transit.

4.0 Overhaul

The unit is largely made of materials that are very corrosion resistant. This allows the unit to be completely stripped, cleaned, then re-built with new electrical parts as required. The internal wiring is 0.8mm² solid core, HTPVC insulated. All the spares required are available. Please state the model number and lamp details. The seal is between the polycarbonate diffuser and the base. The diffuser is retained by the clamp bar. Periodic inspection of the enclosure seal should be carried out to ensure that the seal is sound. The seal can be replaced and, if necessary, secured in position by the application of a very small amount of rubber adhesive and using the joining piece. The seal can be obtained from Chalmit. This job should be carried out in the workshop.

4.1 Cleaning

The body of the luminaire may be cleaned with a mild solution of household detergent and water, after cleaning the body should be washed and wiped with clean water. **The diffuser should not be polished or wiped with a dry cloth as a risk of ignition due to electrostatic discharge may result.** Cleaning of the diffuser with any chemical or hydrocarbon solvent based cleaner may result in severe damage.

4.2 Removal and Replacement of Clamping Bar (if required)

Open the luminaire as above and remove the diffuser or let it swing down. Press the clamping bar towards the closed position, tip forward beyond the closed position and the clamping bar will be released from the body. To replace the clamping bar, put in position on the body with the front edge pointing as far inwards as it will go. Click the bar outwards and bring back to the normal closed position. The clamping bar should then be secured in position, open the clamping bar fully by using hand or screwdriver pressure (avoid damaging the gasket), the clamping bar is then ready to accept the normal closure of the diffuser.

5.0 Fuse Ratings

With the availability of MCB's with a wide range of characteristics, the individual engineer can make a better judgement of what is required. Use MCB's suitable for inrush currents to reduce ratings. Where MCB's are used, the type with the higher short time tripping current ratio used for motor starting and lighting should be specified. The inrush current can be calculated where circuit conditions are known. The inrush currents can be obtained from Chalmit.

The fuse ratings for fluorescent lamp circuits need to take account of three components of circuit current. Where PFC capacitors are fitted, the current inrush can be up to 25 x the rated capacitor current and last 1-2milli seconds The inrush current can be calculated where circuit conditions are known. For luminaires the nominal capacitor current will probably be the determining factor, 0.076A per μ F at 240V, 50Hz (adjust for other supply volts by multiplication, x 6/5 for 60Hz). For HBC fuses use 1.5 x normal capacitor current. All calculations must satisfy wiring regulations.

Note: *Line currents for 240V, 50Hz are as indicated in Table 3.*

6.0 Disposal of Material

The unit is made from combustible materials. The capacitor is of the dry film type and does not contain PCB's. The control gear contains plastic parts and polyester resin. The ignitor contains electronic components and synthetic resins. All electrical components and the body parts may give off noxious fumes if incinerated. Take care to render these fumes harmless or avoid inhalation. Any local regulations concerning disposal must be complied with. Any disposal must satisfy the requirements of the WEEE directive [2002/96/EC] and therefore must not be treated as commercial waste. The unit is mainly made from incombustible materials. The control gear contains plastic, resin and electronic components. All electrical components may give off noxious fumes if incinerated.

6.1 Lamps

Fluorescent lamps in modest quantities are not "special waste". The outer envelope should be broken in a container to avoid possible injury from fragmentation. Avoid inhaling dust. This applies to the UK; there may be other regulations on disposal operating in other countries.

Important: *Do not incinerate lamps.*

6.2 Battery Disposal

Nickel cadmium batteries are defined as 'controlled waste' under the hazardous waste regulations and the user needs to observe a 'duty of care'.

Batteries can be returned to the manufacturers for re-cycling. They must be stored and transported safely and any necessary pollution control forms completed prior to transportation. Take care to fully discharge batteries before transporting or otherwise ensure that there can be no release of stored energy in transit. For further details refer to Technical Department.

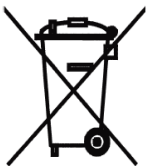

To comply with the Waste Electrical and Electronic Equipment directive 2002/96/EC the apparatus cannot be classified as commercial waste and as such must be disposed of or recycled in such a manner as to reduce the environmental impact.

TABLE 1 - SCHEDULE – HF GEAR – NON EMERGENCY – 110 to 254V					
MODEL	LAMP	NOM VOLTS	AMBIENT TEMP	T RATING	MAX SURFACE TEMP (DUST)
PR2N/118/BI	1 X 18W	110 – 254V With HF Ballast	-25°C ≤ Ta ≤ +50°C	T4	85°C
PR2N/118/BI/SE					
PRSN/118/BI					
PR2N/218/BI	2 X 18W		-25°C ≤ Ta ≤ +50°C		
PR2N/218/BI/SE					
PRSN/218/BI					
PR2N/136/BI	1 X 36W		-25°C ≤ Ta ≤ +50°C		
PR2N/136/BI/SE					
PRSN/136/BI					
PR2N/236/BI	2 X 36W		-25°C ≤ Ta ≤ +50°C		
PR2N/236/BI/SE					
PRSN/236/BI					
PR2N/158/BI	1 X 58W		-25°C ≤ Ta ≤ +50°C		
PRSN/158/BI	1 X 58W		-25°C ≤ Ta ≤ +40°C		
PR2N/258/BI	2 X 58W		-25°C ≤ Ta ≤ +50°C		





PRSN/258/BI	2 X 58W		-25°C ≤ Ta ≤ +40°C		
PR2N/118/BI/120	1 X 18W	120V with Step-up Transformer And 220-254V HF Ballast	-25°C ≤ Ta ≤ +35°C	T4	85°C
PR2N/118/BI/120/SE					
PRSN/118/BI/120					
PR2N/218/BI/120	2 X 18W		-25°C ≤ Ta ≤ +35°C		
PR2N/218/BI/120/SE					
PRSN/218/BI/120					
PR2N/136/BI/120	1 X 36W		-25°C ≤ Ta ≤ +35°C		
PR2N/136/BI/120/SE					
PRSN/136/BI/120					
PR2N/236/BI/120	2 X 36W		-25°C ≤ Ta ≤ +35°C		
PR2N/236/BI/120/SE					
PRSN/236/BI/120					
PR2N/158/BI/120	1 X 58W		-25°C ≤ Ta ≤ +35°C		
PRSN/158/BI/120	1 X 58W		-25°C ≤ Ta ≤ +30°C		
PR2N/258/BI/120	2 X 58W		-25°C ≤ Ta ≤ +35°C		
PRSN/258/BI/120	2 X 58W	-25°C ≤ Ta ≤ +30°C			
Models :- PR2N = GRP Body, PRSN = St.St. Body, BI = Bi-Pin T8 Lamps					
Options :- /SE = Pole Mount Model, /120 = 120V with transformer					

TABLE 2 - SCHEDULE – HF GEAR – EMERGENCY – 110 to 254V					
MODEL	LAMP	NOM VOLTS	AMBIENT TEMP	T RATING	MAX SURFACE TEMP (DUST)
PR2N/118/BI/EM	1 X 18W	110 – 254V With HF Ballast	-25°C ≤ Ta ≤ +45°C	T4	85°C
PR2N/118/BI/EM/SE					
PRSN/118/BI/EM					
PR2N/218/BI/EM	2 X 18W		-25°C ≤ Ta ≤ +45°C		
PR2N/218/BI/EM/SE					
PRSN/218/BI/EM					
PR2N/136/BI/EM	1 X 36W		-25°C ≤ Ta ≤ +45°C		
PR2N/136/BI/EM/SE					
PRSN/136/BI/EM					
PR2N/236/BI/EM	2 X 36W		-25°C ≤ Ta ≤ +45°C		
PR2N/236/BI/EM/SE					
PRSN/236/B/EM					
PR2N/158/BI/EM	1 X 58W		-25°C ≤ Ta ≤ +45°C		
PRSN/158/BI/EM	1 X 58W		-25°C ≤ Ta ≤ +35°C		
PR2N/258/BI/EM	2 X 58W		-25°C ≤ Ta ≤ +45°C		
PRSN/258/BI/EM	2 X 58W	-25°C ≤ Ta ≤ +35°C			
PR2N/118/BI/EM/120	1 X 18W	120V with Step-up Transformer And 220-254V HF Ballast	-25°C ≤ Ta ≤ +35°C	T4	85°C
PR2N/118/BI/EM/120/SE					
PRSN/118/BI/EM/120					
PR2N/218/BI/EM/120	2 X 18W		-25°C ≤ Ta ≤ +35°C		
PR2N/218/BI/EM/120/SE					

PRSN/218/BI/EM/120				
PR2N/136/BI/EM/120	1 X 36W		-25°C ≤ Ta ≤ +35°C	
PR2N/136/BI/EM/120/SE				
PRSN/136/BI/EM/120				
PR2N/236/BI/EM/120	2 X 36W		-25°C ≤ Ta ≤ +35°C	
PR2N/236/BI/EM/120/SE				
PRSN/236/BI/EM/120				
PR2N/158/BI/EM/120	1 X 58W		-25°C ≤ Ta ≤ +35°C	
PRSN/158/BI/EM/120	1 X 58W		-25°C ≤ Ta ≤ +25°C	
PR2N/258/BI/EM/120	2 X 58W		-25°C ≤ Ta ≤ +35°C	
PRSN/258/BI/EM/120	2 X 58W		-25°C ≤ Ta ≤ +25°C	
Models :- PR2N = GRP Body, PRSN = St.St. Body, BI = Bi-Pin T8 Lamps Options :- /SE = Pole Mount Model, /120 = 120V with transformer, EM = 3hr Emergency duration				

Chalmit Lighting is a leading supplier of Hazardous Area and Marine Lighting products

		<p>CHALMIT LIGHTING PO Box 5575 Glasgow, G52 9AP Scotland</p>			
Telephone:	+44 (0) 141 882 5555	Registered No:	669157		
Fax:	+44 (0) 141 883 3704	Registered Office:	Mitre House, 160 Aldersgate Street, London, EC1A 4DD		
Email:	info@chalmit.com				
Web:	www.chalmit.com				

For technical support, please contact: techsupport@chalmit.com

Note: Chalmit Lighting reserves the right to amend characteristics of our products and all data is for guidance only.